



Review Article

Ideal radiographs: An insight

Latika Bachani^{1,*}, Monika Singh¹, Anshul¹, Ashok Lingappa²¹Dept. of Oral Medicine and Radiology, Faculty of Dental Sciences, SGT University, Gurugram, Haryana, India²Dept. of Oral Medicine and Radiology, Bapuji Dental College and Hospital, Davangere, Karnataka, India

ARTICLE INFO

Article history:

Received 21-07-2020

Accepted 19-08-2020

Available online 07-10-2020

Keywords:

Ideal radiograph

Dental radiography

Radiology

ABSTRACT

Dental radiography is the art of producing an image or picture for intra-oral or extra-oral structures on a dental film using x-rays. An ideal radiograph should be capable of providing all the necessary information required to achieve a correct diagnosis. Furthermore, a good radiograph not only helps in making a proper diagnosis, but it also aids in adequate treatment planning. Hence, a radiologist must be aware of the various characteristics of an ideal radiograph and the various factors governing them to achieve a proper diagnosis.

© 2020 Published by Innovative Publication. This is an open access article under the CC BY-NC license (<https://creativecommons.org/licenses/by-nc/4.0/>)

1. Introduction

In British English the word “ideal” means: “Perfect, or “best possible”.¹

John Cameron in 1970 stated that, “There was negligible risk from x-rays but many radiographs had poor image quality so that the risk from a false negative was significant”. Image quality and patient exposure are 2 important aspects of radiography. Inferior quality of the radiographs may affect the outcome of diagnosis and thereby jeopardize treatment.

In Sir H.M.WORTH’s words: “an ideal radiograph is the one which has desired density and overall blackness and which shows the part completely without distortion with maximum details and has the right amount of contrast to make the details fully apparent”.x’

1.1. Factors related to radiation beam

1. Kilovoltage peak
2. Exposure time
3. Milliamperage
4. Tube-film distance

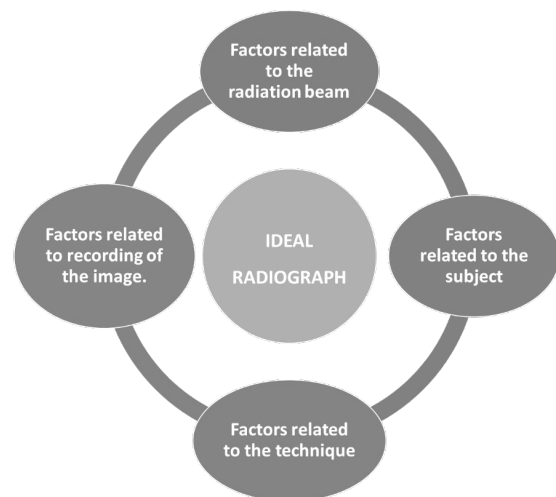

Fig. 1: Factors affecting ideal radiograph

5. Focal spot
6. Collimation
7. Filtration
8. Equipment efficiency²

* Corresponding author.

E-mail address: latikabachani@gmail.com (L. Bachani).

1.2. Focal spot

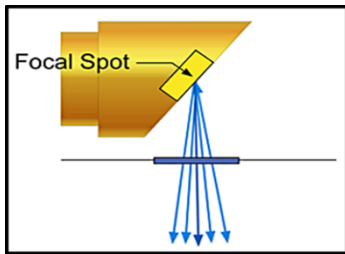

Fig. 2: Illustration of focal spot

The focal spot is the area on the target to which the focusing cup directs the electrons from the filament (Figure 2). The sharpness of the radiographic image increases as the size of the focal spot—the radiation source decreases. Typically, the target is inclined about 20 degrees to the central ray of the x-ray beam. This causes the effective focal spot to be almost 1.x 1mm, as opposed to the actual focal spot, which is about 1 x 3mm.

1.3. Variation of focal spot size with changes in tube operating conditions

It is called as focal spot blooming

1. Focal spot size increases in direct proportion to tube current.
2. Focal spot size will decrease slightly with increasing kVp.³

1.4. Tube voltage (kVp)

1. Voltage is the measurement of electrical force that causes electrons to move from the cathode to the anode.
2. Voltage increased: speed of electrons increased: force and energy of electrons increased: greater penetrating ability of the x-ray beam.
3. It is a measure of Beam energy(Figure 3).
4. Dental radiography requires the use of 65-100 kVp.⁴

1.5. Tube current (mA)

1. It is the flow of electrons through the tube, from cathode to anode and then back to the filament (Figure 4).
2. It determines the quantity of radiation or the number of photons reaching the patient and the film.

1.6. Exposure time (S)

Determines the duration of exposure hence the number of photons generated (Figure 5).

$$\text{Beam Quantity} = \text{Tube current (mA)} \times \text{Exposure time (s)}.$$

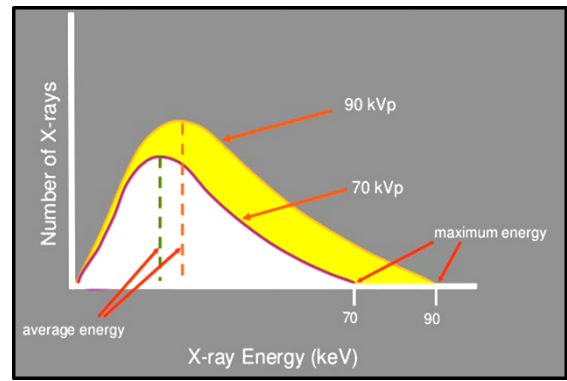

Fig. 3: Effect of tube voltage on beam energy

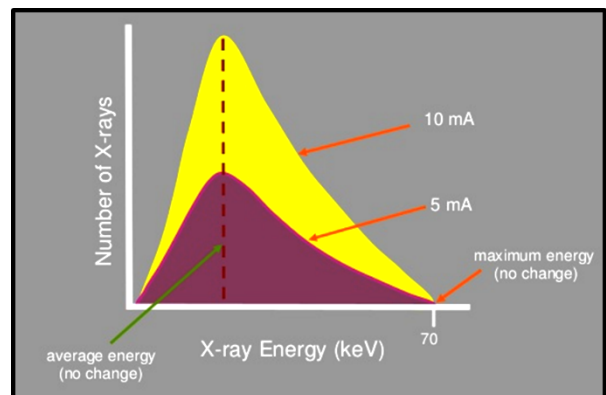

Fig. 4: Effect of tube current on beam energy

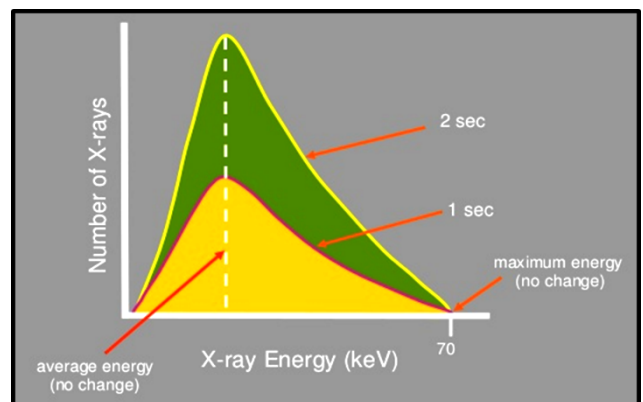

Fig. 5: Effect of exposure time on beam energy

1.7. Filtration

An x-ray beam consists of spectrum of photons of different energies, but only photons of sufficient energy to penetrate through anatomic structures and reach the image receptor are useful for diagnostic radiology.

The rest of low energy photons are removed by placing an aluminium filter in the path of the x-ray beam. This process is called as filtration.⁵

It is of 2 types:

1. Inherent filtration: approx. 0.5-1mm
2. Added filtration: it is added in 0.5mm increments.

Total filtration: inherent plus added filtration. In dental radiography, machines operating at or below 70kVp, total filtration is minimum 1.5mm aluminium thickness. Above 70 kVp, it is 2.5mm.³

1.8. Beam intensity

It is the product of the quantity and quality per unit of area per unit of time of exposure.

$$\text{Intensity} = \frac{\text{No. of photons} \times \text{Energy of photons}}{\text{Area} \times \text{Exposure time}}$$

2. Distance

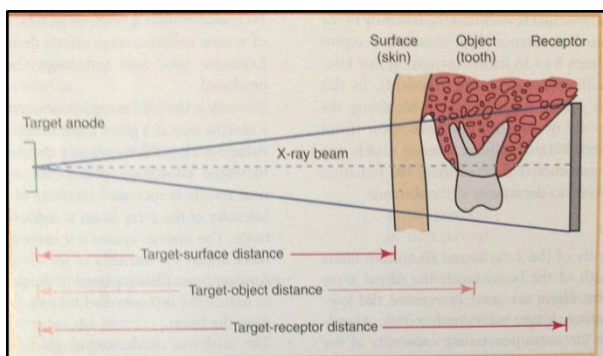

Fig. 6: Effect of distance on x-ray beam intensity

Distances that must be considered when exposing a dental radiograph are:

1. Target-surface distance
2. Target-object distance
3. Target-receptor distance

Distance has a marked effect on the intensity of the x-ray beam (Figure 6).⁴

Inverse Square Law

$$\frac{I_1}{I_2} = \frac{D_2^2}{D_1^2}$$

The inverse square law describes the principle of dose reduction as distance from the source increases.⁵

This assumes a point source. If radiation spreads over a spherical area, as the radius increases, the area over which the dose is distributed increases according to $A=4\pi r^2$ where A is the area, π is pi and r is the radius of the sphere.

Therefore, the dose is proportional to the inverse of the square of the radius. Thus if you double the distance you reduce the dose by a factor of four.³

3. X-Ray Beam Characteristics

The ideal X-ray beam used for imaging should be:

1. Sufficiently penetrating, to pass through the patient and react with the film emulsion and produce good contrast between the different shadows.
2. Parallel, i.e. non-diverging, to prevent magnification of the image.
3. Produced from a point source, to reduce blurring of the edges of the image, a phenomenon known as the penumbra effect.⁶

4. Factors Related to the Subject

1. Subject thickness
2. Subject density

4.1. Subject density and thickness

1. Greater the subject thickness and density, greater the attenuation of X-ray beam, lighter the image obtained.
2. Order of densities:
3. Enamel>dentin>cementum>bone>muscle>fat>air
4. Denser objects: Radiopaque
5. Less dense objects: Radiolucent

5. Factors Related to Technique

1. Patient positioning
2. Placement and positioning of the film
3. Angulation of the X-ray beam²

5.1. Ideal patient positioning

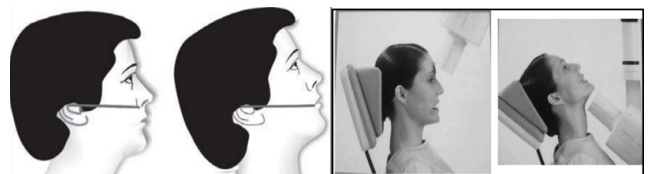

Fig. 7: Patient and tube head position for intra-oral radiographs

Basic Principles of Projection Geometry by: Manson and Lincoln

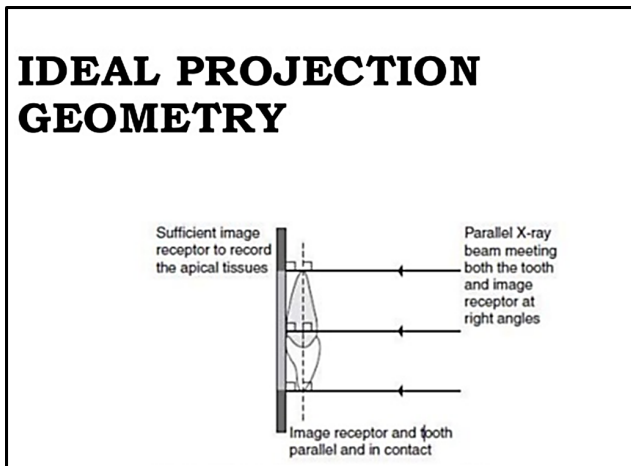

Fig. 8: Ideal projection geometry

1. Focal spot should be as small as possible.
2. Focal spot to object distance should be as long as possible.
3. Object to film distance should be as small as possible.
4. Long axis of object and film plane should be parallel to each other.
5. X-ray beam should strike the object and film at right angles.
6. There should be no movement of the patient, tube or film during the exposure.

Anatomy of oral cavity does not always allow all these ideal positioning requirements to be satisfied.

So to overcome these problems, 2 techniques have been developed in periapical radiography:

1. Bisecting Angle Technique
2. Paralleling Technique⁵

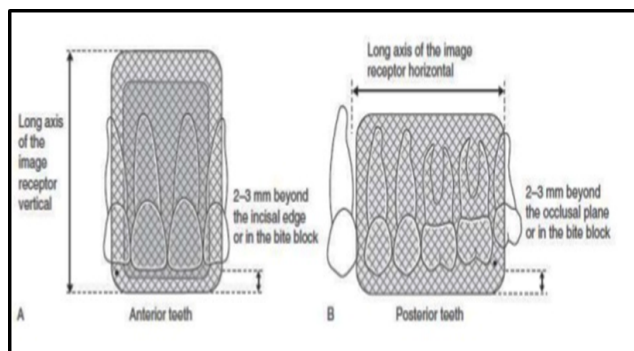

Fig. 9: Ideal film positioning

5.2. Ideal image receptor positioning

1. Receptor should be positioned to cover the prescribed area of the teeth to be examined.

2. Receptor must be positioned parallel to the crowns of both maxillary and mandibular teeth.

5.3. Angulation of the x-ray beam

Vertical angulation should be given as per the required tooth to be imaged.

Horizontal angulation should be kept zero to avoid overlapping of the proximal surfaces.

1. Vertical angulation is steep: foreshortening of the image
2. Vertical angulation is less: image elongation⁴

Factors related to recording of the image

1. Reduction in secondary radiation
2. Films and film storage
3. Intensifying screens
4. Film processing
5. Ways to reduce scattered radiation:
6. Use a relatively low kVp
7. Collimate the beam
8. Use grids in extraoral radiography.⁴

6. Film Storage

Ideally films should be stored at:

1. Cool, dry conditions.
2. Away from all sources of ionizing radiation.
3. Away from chemical fumes including mercury and mercury-containing compounds.²

6.1. Ideal dark room conditions

1. General cleanliness daily of work surfaces and film hangers.
2. Light-tightness checked yearly by standing in the dark room in total darkness with the door closed and safelights switched off and visually inspecting for light leakage.
3. Recommended room temperature : 70⁰ F
4. > 90⁰ F: film fogging.
5. Recommended relative humidity level : 50-70%

6.2. Safe-lighting

1. Low intensity light composed of long wavelengths in the red-orange portion of the visible spectrum.
2. Low wattage bulb 7.5 or 15 watts.
3. Safelight filter: to remove short wavelengths in the blue-green portion of the visible light spectrum that are responsible for damaging the x-ray film.
4. Should be placed atleast 4 feet away from the work area.
5. Films unwrapped too close to the safelight or exposed to the safelight for more than 2-3 min appear fogged.

6.3. Film processing solutions

1. Always made up to the manufacturer's instructions.
2. Always at the correct temp.
3. Changed regularly, ideally every 2 weeks..
4. Monitored for deterioration: by using radiographs of step-wedge phantom.

6.4. Cassettes

1. Clean regularly.
2. Check for light-tightness
3. Check for screen-film contact

7. Characteristics of an Ideal Radiograph

1. Visual characteristics:
2. Density
3. Contrast
4. Geometric characteristics:
5. Sharpness or detail, resolution or definition
6. Magnification
7. Distortion
8. Anatomical accuracy of radiographic image
9. Adequate coverage of the anatomical region of interest.

8. Radiographic Density

The overall degree of darkening of an exposed radiographic film.⁴

8.1. Factors affecting the radiographic density:

8.1.1. First degree factors

1. Milliampere current (mA)
2. Kilo voltage peak (kVp)
3. Exposure time (s)
4. Source-to-film distance (d)

Increase in kVp increases the density.

Increase in mA increases the density.

Source-to-film distance (d): Reducing the distance between the focal spot and film also increases film density.

8.1.2. Second degree factors

1. Subject thickness: The thicker the subject, the more the beam is attenuated and the lighter the resultant image.
2. Subject density: The greater the density of a structure within the subject, the greater the attenuation of the x-ray beam directed through that subject or area.
3. Type of film
4. Screens
5. Grids
6. Amount of filtration used
7. Development conditions

8. Fog²

9. Radiographic Contrast

1. Defined as the differences in densities between light and dark regions on a radiograph.
2. A film that shows very light and very dark areas has high contrast or a short gray scale as there are few shades of gray from one extreme to the other.
3. A radiograph that has many shades of gray is referred to as one with low contrast or long gray scale. [Wide latitude]

9.1. Factors affecting radiographic contrast

1. Subject contrast
2. Film contrast
3. Operating kVp
4. Exposure time
5. Scattered radiation

10. Radiographic Speed

1. It is the amount of radiation required to produce a radiograph of standard density.
2. Film speed is expressed as the reciprocal of the exposure.
3. Controlled by silver halide grains and their silver content.
4. Kodak ultraspeed (group D)
5. Kodak Insight (group E and F)
6. Film processing at higher temp. Increases the film speed but increases film fog and graininess.⁵

11. Radiographic Latitude

1. It is the measure of the range of exposures that may be recorded as a series of usefully distinguishable densities on a film.
2. The wider the latitude of a film, the greater the range of object densities visualized.⁷

12. Radiographic Noise

1. It is the appearance of uneven density of a uniformly exposed radiographic film.
2. Major causes:
3. Radiographic mottle and radiographic artifact
4. Radiographic mottle is uneven density resulting from the physical structure of the film or intensifying screens.
5. Radiographic artifacts are defects caused by errors in film handling, such as fingerprints or bends in the film, or errors in film processing, such as splashing developer or fixer on a film or marks or scratches from rough handling.

6. On intraoral dental film, mottle may be seen as film graininess, due to visibility of silver grains in the film emulsion.
7. It is most evident when high-temperature processing is used.
8. Mottle is also evident when the film is used with fast intensifying screens.
9. Two important causes of the phenomenon are quantum mottle and screen structure mottle.
10. Quantum mottle is caused by a fluctuation in the number of photons per unit of the beam cross-sectional area absorbed by the intensifying screen.
11. Screen structure mottle is graininess caused by screen phosphors.

It is most evident when fast screens with large crystals are used.⁶

In diagnostic radiology, only quantum mottle has importance. Quantum mottle is most evident when fast film-screen combinations are used. It will be greater with high kVp x-rays because they produce a higher screen intensification factor.⁸

13. Geometric Characteristics

13.1. Image sharpness and resolution

Sharpness refers to the ability of a radiograph to reproduce distinct outlines of the object.

Resolution refers to the ability of the radiograph to reproduce smallest details of objects that are close together on a dental radiograph.

1. Panoramic film-screen combinations resolution: 5 line pairs per mm.
2. Periapical film resolution: more than 20 line pairs per mm.

13.2. Factors controlling sharpness of the image

1. Geometric unsharpness
2. Motion unsharpness
3. Film unsharpness
4. Fog unsharpness
5. Intensifying screen unsharpness

13.3. Geometric unsharpness

1. Focal spot size
2. Target-film-distance
3. Object-film-distance

13.4. Motion unsharpness

Due to movement of:

1. Patient

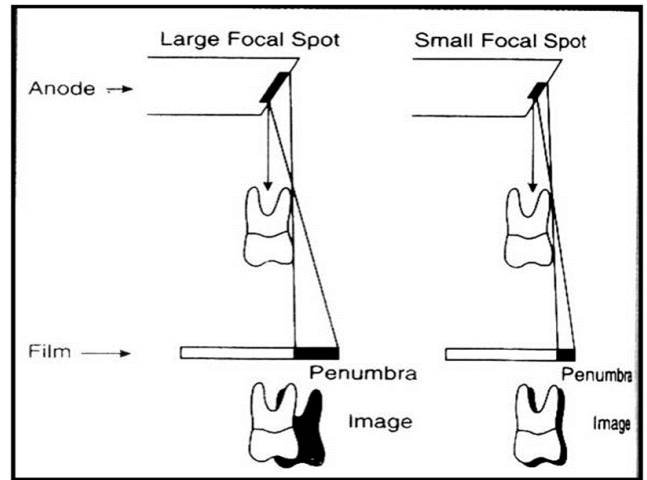

Fig. 10: Effect of focal spot size

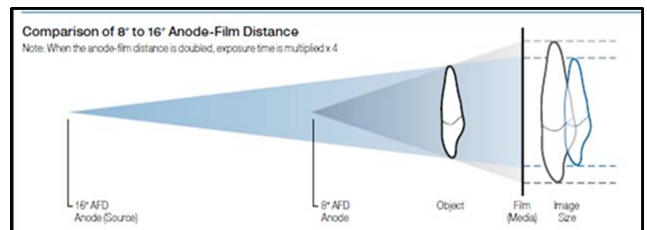

Fig. 11: Effect of target-film-distance

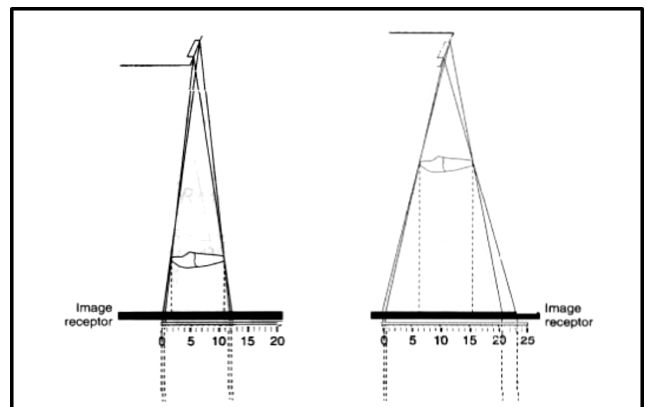

Fig. 12: Effect of object-film distance

2. Tube head
3. Film

It can be reduced by decreasing the exposure time.

13.5. Film unsharpness

1. Grain size of emulsion crystals
Faster speed film: larger grain size: reduced image sharpness
2. Single and double emulsion and film thickness:

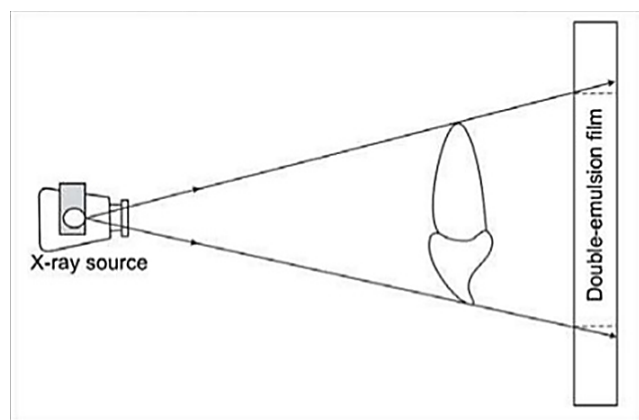

Fig. 13: Parallax on double emulsion film

The presence of an image on each side of a double emulsion film also causes a loss of image sharpness through parallax. Parallax results from the apparent change in position or size of a subject when it is viewed from different perspectives. Because dental film has a double coating of emulsion and the x-ray beam is divergent, the images recorded on each emulsion vary slightly in size. In intraoral images, the effect of parallax on image sharpness is unimportant but is most apparent when wet films are viewed. Under these conditions the emulsion is swollen with water and the loss of image sharpness caused by parallax is more evident. When intensifying screens are used, parallax distortion contributes to image unsharpness because light from one screen may cross the film base and reach the emulsion on the opposite side. This problem can be solved by incorporating dyes into the base that absorb the light emitted by the screens.

13.6. Fog unsharpness

1. Scattered radiation
2. Unsafe safety light in the darkroom
3. Chemical fog: due to prolonged development or development at high temperature.
4. Potassium bromide or restrainer prevents chemical fogging.
5. Radiograph should be adequately rinsed before putting it in the fixer.
6. After fixing it should be thoroughly washed.
7. Temp. Difference between processing solution and rinsing water should not be more than 15⁰ F.
8. Film should be adequately dried.⁴

13.7. Intensifying screen unsharpness

1. Improper film contact with the screen.
2. Radiographic mottle: it refers to uneven density resulting from the physical structure of the film or the intensifying screen.⁸

14. Image Magnification

1. It refers to a radiographic image that appears larger than the actual size of the object it represents.
2. It is because of the divergent path of the x-rays from the focal spot.

14.1. Factors affecting image magnification

1. Target - film distance
2. Object - film distance
3. Use of intensifying screens

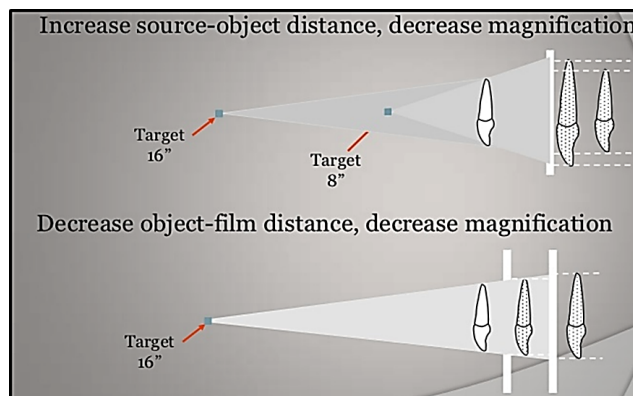

Fig. 14: Effect of target-film and object-film distance

14.2. Intensifying screens

Screens increase the distance between the film and the object and hence contribute to a certain amount of image magnification.²

15. Image Distortion

1. It refers to the variation in the true size and shape of the object being recorded.
2. It may occur due to unequal magnification of different parts of the same object.
3. It may be due to:
4. Object-film alignment
5. X-ray beam angulation

16. Anatomical Accuracy

1. It occurs when the anatomical structures are reproduced on the film in the same relationship as they normally appear.
2. A radiograph is said to have anatomical accuracy when:
3. Labial and lingual CEJ of the anterior teeth are superimposed.
4. Buccal and lingual cusps of posterior teeth are superimposed.

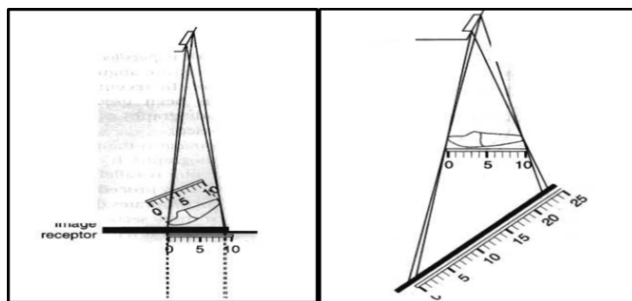

Fig. 15: Object-film alignment

- Buccal and lingual portions of the alveolar crest are superimposed.

17. Radiographic Coverage

Adequate coverage of the area of interest depends upon:

- Proper alignment of the film and radiation beam to the area of interest.
- Proper selection of the film type.
- Proper selection of the projection technique.⁷

18. Ideal Quality Criteria

RATING	QUALITY	BASIS
1	Excellent	No errors of patient preparation, exposure, positioning, processing or film handling
2	Diagnostically acceptable	Some errors present but which do not detract from the diagnostic utility of the radiograph.
3	Unacceptable	Errors present which render the radiograph diagnostically unacceptable.

Fig. 16: Subjective quality rating criteria for film captured images

19. IOPA

- The image should include the correct anatomical area together with the apices of the tooth/ teeth under investigation with at least 2mm of periapical bone.
- There should be no overlap of proximal surfaces of the teeth.
- The image should have acceptable definition with no distortion or blurring.
- The image should have optimum density and contrast to facilitate interpretation.
- The film should be free of cone cutting and other film handling errors.
- The desired density and contrast for the film captured images will depend on the clinical reasons for taking the radiograph, eg.,

- To assess caries, restorations and periapical tissues films should be well exposed and show good contrast.
- To assess periodontal status films should be underexposed to avoid burnout of the thin alveolar crestal bone.

20. OPG

- All the upper and lower teeth and their supporting alveolar bone should be clearly demonstrated.
- The whole of the mandible should be included.
- Magnification in the vertical and horizontal planes should be equal.
- The right and left molar teeth should be equal in their mesio-distal dimension.
- The density across the image should be uniform with no air shadow above the tongue creating a radiolucent band over the roots of the upper teeth.
- The image of the hard palate should appear above the apices of the upper teeth.
- Only the slightest ghost shadows of the contralateral angle of the mandible and the cervical spine should be evident.
- There should be no artefactual shadows due to dentures, earrings and other jewelry.
- The patient identification label should not obscure any of the above features.
- The image should be clearly labelled with the patient's name and date of the examination.
- The image should be clearly marked with a Right and/or Left letter.

21. Conclusion

An ideal radiograph is the end result of the interplay of various factors as described above. It should be capable of providing all the necessary information required to achieve a correct diagnosis. Furthermore, a good radiograph not only helps in making a proper diagnosis, but it also aids in adequate treatment planning. Hence a radiologist must be aware of the various characteristics of an ideal radiograph and the various factors governing them to achieve a proper diagnosis.

22. Source of Funding

None.

23. Conflict of Interest

None.

References

- Available from: <http://dictionary.cambridge.org/>.
- Karjodkar FR. Textbook of Dental and Maxillofacial Radiology. 2nd ed. Jaypee Brothers Medical Publishers (P) Ltd; 2011.

3. Curry TS, Dowdey JE, Murry RC. Christensen's physics of diagnostic radiology. 4th ed. Philadelphia: Pa: Lea & Febiger; 1990.
4. Iannucci JM, Howerton LJ. Dental radiography principles and techniques. 4th ed. Saunders; 2011.
5. White SC, Pharoah MJ. Oral radiology: principles and interpretation. 6th ed. and others, editor. Mosby Elsevier; 2008.
6. Whaites E. Essentials of dental radiography and radiology. 3rd ed. Churchill Livingstone; 2002.
7. Frommer HH. Radiology In Dental Practice.
8. Barnes GT. Radiographic mottle: A comprehensive theory. *Med Physics*. 1982;9(5):656–67.

Author biography

Latika Bachani Assistant Professor

Monika Singh Post Graduate

Anshul Post Graduate

Ashok Lingappa Professor and Head

<p>Cite this article: Bachani L, Singh M, Anshul, Lingappa A. Ideal radiographs: An insight. <i>IP Int J Maxillofac Imaging</i> 2020;6(3):56-64.</p>
